

JT2003
Professional Multimeter
User Manual

Preface

Dear Customers:

Thank you for purchasing this brand new Jaltest instrument. For the purpose of using the instrument properly, we ask you to read this instruction manual carefully and thoroughly before putting this instrument into service, especially the sections related with "Safety Precautions". After you have read this instruction manual thoroughly, we suggest you place this instruction manual at a convenient location for future reference.

Limited Warranty Liability

Cojali S. L. will guarantee this product is free from any defect in material and process within one year from the date of purchase. This warranty is not applicable to fuses, disposable batteries, or any damage resulted from any accident, negligence, misuse, retrofitting, contamination, misoperation or handling.

The repair or replacement of a defective item does not change the start date of the warranty period of the whole product, which will be of one year. Under no circumstances shall the Seller be responsible for the repairing carried out by staff not belonging to its organization.

If warranty service is required within warranty period, please contact your nearest service center authorized by Cojali S. L. to obtain authorized information on return of the product; then send the product together with the description of problems to that service center. This warranty is the only compensation that you can obtain.

Otherwise, Cojali S. L. will not provide any expressed or implied guarantee, such as the implied guarantee to certain specific item. Meanwhile, Cojali S. L. will not be responsible for any special incidental or indirect damage or loss that is caused by any reason or speculation.

Cojali S. L. is not responsible for any damages caused by its guaranteed products. That is, Cojali S. L. is only responsible for the restitution of the damaged product. The Seller shall not be responsible, in any case, for the defects in the supplied goods for a period exceeding one year from the start of the warranty period for Jaltest products.

Table of Contents

Title	Page
I. Overview	4
II. Features	4
III. Accessories	5
IV. Safe operation rules	6
V. Electrical Symbols	9
VI. Comprehensive Specifications	12
VII. Overall Configuration	13
VIII. Function Selection, Button Definition and Double Mode Display	14
IX. Measurement Operating Instruction	19
X. Technical specifications	31
XI. Maintenance and Repair	38

I. Introduction

JT2003 is a hand-held industrial grade digital multimeter that is highly reliable, safe and durable. It is designed with IP65 rating and 2 meter drop proof. It is a multimeter of 3 5/6 digit true RMS with large multiple display screen and auto ranged. It can measure AC/DC voltage or current, resistance, diode, circuit continuity, capacitance, frequency, duty ratio, temperature, and motor phase voltage.

Required test function and trouble-shooting function can be performed in petroleum, chemical and aviation, strong electromagnetic field, and other harsh working environments. This series of multimeter is German GS certified.

II. Features

1. Completely sealed, protection level is IP65.
2. Withstand 2 meters fall.
3. Dustproof, complying with IEC60529 IP65.
4. Waterproof, complying with IEC60529 IP65 and IEC over voltage electrical safety standard 61010-1:2001.
5. Large LCD dual mode display, 6,000 counts dual slope analog-to-digital converter (for conversion rate, 5 times/second).
6. Full function measurement error protection, enabling to sustain lightning impulse voltage more than 8kV.
7. True Root Mean Square (TRMS) AC voltage and current can precisely measure non-linear signals.
8. AC+DC measurement mode: AC+DC (AC is combined with DC), defined as the square root of $\sqrt{AC^2+DC^2}$
9. AC voltage peak capture (250 μ s) measurement.
10. The AC and DC voltage and current up to 1000V and 20A can be measured (pay attention to the alarm prompt).

11. LOW PASS FILTER guarantees precise measurement of voltage and frequency of variable speed drivers (VSD).
12. MOTOR TEST three phase rotation test can identify motor phase.
13. LoZ voltage measurement, which provides a low impedance to the conductor circuit to get more accurate measurement and detect ghost voltage.
14. Capacitance range is 60.00mF.
15. Capture MAX/MIN, mean, and peak values and automatically record the transients and changes.
16. Relative REL mode which eliminates the interference of test conductor in resistance measurement.
17. Manual and auto select range that allows maximum flexibility.
18. Auto backlight function. Turn on and off the LED backlight automatically according to the brightness of environment.
19. Battery Service Life - with no backlight: 82 hours (alkaline battery).

III. Accessories

Open the package box, take out the meter, and check whether the following accessories are missed or damaged.

If any is missing or damaged, please contact your supplier immediately.

1. Instruction Manual: _____ 1
2. Probe: _____ 1pair

IV. Safe Operation Rules

1. Safety Certification

- 1) CE, TUV/GS certification standards:
 - EN 61010-1:2010
 - EN 61010-2-030:2010
 - EN 61010-2-033:2012
 - EN 61010-031:2015
 - EN 61010-1:2013
- 2) CAT III 1000V, CAT IV 600V
- 3) Pollution level 2
- 4) Double insulation safety standard

2. Before Operation

Prior to operating this instrument, read this instruction manual carefully and follow the requirements. Store this manual in a proper place so as to refer to it when necessary. Send this manual with the instrument to all subsequent users.

3. Safety Instructions and Precautions

- 1) This instrument can be operated and maintained only by trained professionals.
- 2) To prevent electric shock, when the operating voltage is more than 30Vrms DC or AC, preventive measures should be taken.
- 3) The measuring instrument can only be used in line circuit of < 20A; its nominal voltage is 1000V (CAT III).
- 4) For the purpose of safe connection, the nominal cross-section of the cable to be connected should be taken into consideration.
- 5) Measuring a dangerous electric device should be carried out under the guidance of a qualified electrician only.

- 6) Only the restrained control area on this instrument can be touched, the display elements should not be covered.
- 7) If it becomes necessary to open the instrument to replace the fuse, it should be conducted by a qualified professional. Before opening the instrument, turn off the power supply of the instrument, and disconnect all circuit connection.
- 8) Do not modify this instrument without authorization.
- 9) Only the accessories supplied with this product or same specification can be used.
- 10) Any change or modification to this instrument will result in voiding all warranty and guaranteed claim from the manufacturer.
- 11) Do not use this instrument in a explosive environment.
- 12) Prior to use, always inspect whether the instrument is in peak operating sequence or not. Carry out measuring by connecting the instrument with a given power supply.
- 13) It is forbidden to use this instrument if the battery compartment is open.
- 14) Inspect the batteries before use or replacement.
- 15) The storage space should be kept dry.
- 16) In case of battery leakage, do not use this instrument before our customer service department carries out inspection.
- 17) Battery acid (electrolyte) is alkaline, and conducts electricity. There may be risk of skin burn if battery leaks.
In case the battery acid contacts with your skin or clothing, immediately wash with large amount of water thoroughly. If the battery acid enters your eyes, wash them immediately with a large amount of water and seek medical advice in time.

18) In conditions that cannot guarantee the safety of operator and those around, stop using this instrument. For example:

- The case is smashed
- Test leads are damaged
- Battery leakage
- Storage in improper place for a long time

4. Range of Applications

This instrument complies with standard of CAT III measuring category and rated voltage of 1000V.

CAT III measuring category is used in three phase distribution circuit, such as indoor commercial lighting circuit, industrial equipment switchboard, multiphase motor and multiphase electrical systems.

This instrument complies with standard of CAT IV measuring category and rated voltage of 600V.

CAT IV is used in outdoor three-phase utility power supply equipment that is initially connected, such as power distribution system of power station, over-current protection device before the power instruments, instruments of equipment connected with outdoor building.

The rated voltage for probe assembly used in main line measurement should comply with measurement category III and IV of IEC 61010-31 , and the rated voltage should be maximum voltage of the circuit to be measured.

This instrument should be used in the application field limited in this manual. Any deviation from this application should be considered to be improper and not inspected, and may result in accident or damage to the instrument.

Any improper use may completely void the claim to the supplier and the right of warranty. The manufacturer will not be liable for property damage and personal injury caused by the following reasons:







1. Not follow the instruction manual
2. Modify the instrument without prior approval from the manufacturer
3. Use accessories without prior approval from the manufacturer
4. Use this instrument under the influence of alcohol, drugs and medicines

It is not allowed to use this instrument in following conditions:

1. Potential explosive environment: This instrument is not explosion-proof
2. In case of raining or other rainfall: Risk of electric shock

V. Electrical symbols

1) Device Safety Identification

	Double Insulation
	Grounding
	Warning Hint
	AC/DC Symbol
	High Voltage Warning Symbol
	In compliance with the directive of European Union
	Tested and approved by TUV Product Services



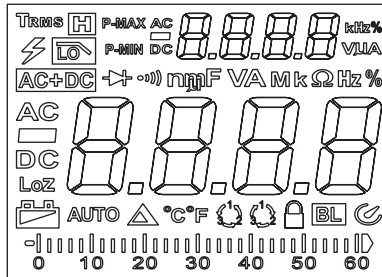





2) LCD Full Display Symbol





N°	Symbol	Description	N°	Symbol	Description
1	TRMS	True RMS Function Measurement	5	P-MAX/P-MIN	PEAK Value Measurement
2		Data Hold	6	P-MAX P-MIN	MAX/MIN Measurement
3		High Voltage Warning	7		Diode Measurement and Circuit Continuity Measurement
4	LPF	Voltage measured by low pass filter (intercept the voltage higher than 1 kHz)	8	AC+DC	AC+DC Measurement

JT2003

Professional Multimeter User Manual

N°	Symbol	Description	N°	Symbol	Description
9	AC/DC	AC/DC Prompt	20	$\mu\text{A}, \text{mA}, \text{A}$	Current Units: Microampere, Milliampere, Ampere
10		Negative Reading	21	$\Omega, \text{k}\Omega, \text{M}\Omega$	Resistance Units: Ohm, Kilohm, Megohm
11	LoZ	AC Low Impedance	22	$\text{nF}, \mu\text{F}, \text{mF}$	Capacitance Units: Nanofarad, Continuity Measurement Microfarad, Millifarad
12		Low Voltage of Working Battery in Meter	23	Hz, kHz, MHz	Frequency Units: Hertz, Kilo, Hertz, Mega Hertz
13	AUTO	Auto Range	24	%	Duty Ratio Measurement Unit
14		Relative Measurement	25		Auto-Off
15	 1-2-3	Positive Direction of Phase Sequence Rotary Measurement	26	-8.8.8.8	Main Display Measurement Value
16	 3-2-1	Reverse Direction of Phase Sequence Rotary Measurement	27	-8.8.8.8	Secondary Sub Display Measurement Value
17		Phase Sequence Measurement Enabling State Identification symbol	28	XXXX	Secondary Sub Display: storage Number, Set Value
18	BL	Auto Backlight	29	H XX:XX	Secondary Sub Display: Hour, xJcxx Time Value
19	mV, V	Voltage Units: Millivolt, Volt	30		Analogue Bar with 31 Sections

VI. Comprehensive Specifications

1. Overload protection voltage between various input terminals and grounding is 1 000V.
2. 20A Terminal (CE): FF 11A H 1000V fast-melting fuse (Φ10x38) mm.
3. mA/μA Terminal (CE): FF 600mA H 1000V fast-melting fuse (Φ6x32) mm.
4. Maximum Display: 6000 bits.
5. Update Rate: 5 times/second over-range displays "**OL**".
6. Others.
 - Range: MANUAL/AUTO
 - Polarity: Automatic
 - Operation Temperature: 0°C ~ 40°C (32 °F ~ 104°F)
 - Storage Temperature: -10°C ~ 50°C (14°F ~ 122°F)
 - Relative Humidity: 0°C ~ 30°C below is ≤75%, 30°C ~ 40°C ≤50%
7. Operation Altitude: 0 ~ 2,000m
8. Batteries in the unit: 6F22 9V
9. Low Battery: LED displays  or  symbol
10. Overall Dimension: About 195x95x58 mm
11. Weight: About 473g (including batteries)
12. Electromagnetic Compatibility:
 - Under 1V/m radio-frequency field: Total accuracy = specified accuracy + 5% of range, there is no specified specification in radio-frequency field of 1V/m and more.

JT2003

Professional Multimeter
User Manual

VII. Overall Configuration

1. Auto backlight sensing window
2. LCD display
3. Function button
4. Function selection switch
5. Measurement input terminals
6. Strap hook
7. Flashlight window
8. Multimeter probe locating stand
9. Battery cabinet fixing screw
10. Case support

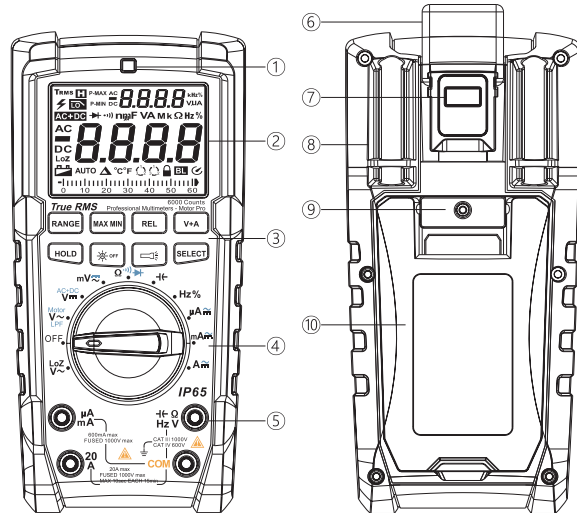





VIII. Function Selection, Button Definition, and Dual Display Mode

1. Feature Selection

Features	Description
V~ V= V≍	AC or DC Voltage Measurement
Ω	Resistance measurement
▶ 	Diode PN-Junction Voltage Measurement
•)	Circuit Continuity Measurement
⊖ 	Capacitance Measurement
Hz	Frequency Measurement
%	Duty Ratio Measurement
μA≍ mA≍ 10A≍	AC/DC Current Measurement
LPF	AC voltage Low Pass Filter Measurement
LoZ	On-line AC Voltage Low Impedance Measurement
MOTOR	Three phase Motor Rotary Phase Sequence, Voltage Phase Sequence Identification Measurement
AC + DC	(AC+DC) Measurement
OFF	Turn off the power

2. Button Definition

- RANGE Button: Press to change Auto/Manual range, it will jump upward one stall when it is pressed once, and jump to minimum range when pressing at maximum range. If this button is pressed for more than 2 seconds or changed by rotary disc, it will exit the manual range mode. (Only suitable for: ).
- MAX MIN Button: Press to enter manual range mode and display the maximum value, press it again to display the minimum value, and press it again to display maximum and minimum value. If this button is pressed for more than 2 seconds or changed by rotary disc, it will exit the data record mode. (Only suitable for: ).
- REL Button: Press to enter MANUAL range mode. Take the current displayed value as reference, the different value between measurement value and reference value will be displayed. Press it again to exit relative measurement. (Only suitable for:  ).
- HOLD Button: (suitable for full range). Press this button, displayed value is locked and held, LCD will display "" indicator. Press it again, the lock is released and enter normal measurement mode.
- A-OFF Button: Auto turn off backlight function. If you need to restart the backlight function, turn function knob to OFF position and restart.
- LIGHT Button: Turn on or off the flash light lighting function.
- Hz% Button: Select Hz or % measurement mode.
- PEAK Button: Voltage peak Vp-p, and current peak measurement. Current peak Ip-p: Catch maximum value of signal current when measuring (PEAK-max/PEAK-min)

Remarks:

This function has the same recording mode as that of MAX MIN, but the largest difference between them is that the response time for the peak (PEAK) record is much shorter (250 μ s).

When measuring the actual peak of a sine wave signal, the recording function of the peak can measure the surge of the power supply much more accurately, the transient value of surge.

- SELECT Button: Press to select function (only suitable for combined range). Long press SELECT button when powering on the meter, Auto-OFF function can be cancelled.

3. Operation Instruction of Dual Display Mode:

AC+DC measurement:

In DCV mode, short press SELECT button to enable AC+DC mode: Main display shows AD+DC value, the secondary display will automatically switch to show ACV or DCV value with a time interval of 2s.

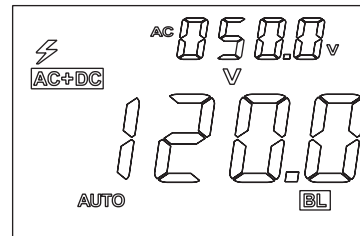
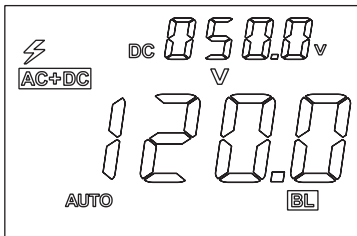

Voltage Measurement Function.

In ACV mode, main display shows ACV value, the secondary display shows frequency.
Short press "SELECT" button to enter L-Pass Filter function, main display shows voltage value and the secondary display shows frequency.

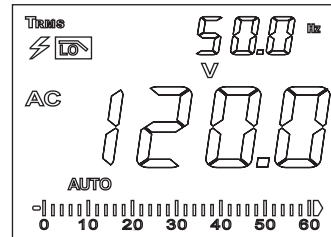
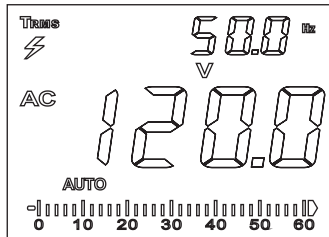

4. Motor rotation direction and phase sequence measurement

In ACV voltage mode, long press SELECT button for more than 2 seconds to enable motor rotation direction function. Main display shows the current voltage value and the secondary display shows operation frequency.

When resting Motor function, short press SELECT button once to enable phase sequence measurement.

Long press SELECT button (more than 2 seconds) to exit Motor function.

Steps: Phase sequence measurement (Detection condition: Above AC 80V, frequency is 40Hz to 80Hz, and it will keep on waiting if the range is exceeded).

- In ACV mode, press and hold SELECT button for at least 2 seconds automatically, then automatically jump to 600.0V range and wait for input signal. It will keep on waiting if there is no input.
- After the first phase sequence is measured and locked, insert the probe into another phase, the LCD displays 1 → 2 → 3 or 3 → 2 → 1; if not move the probe to change input signal, it will time out in 5 seconds.
- Press SELECT button for at least 2 seconds to automatically exit phase sequence mode. Press SELECT button (for at least 2 seconds) to exit Motor function.

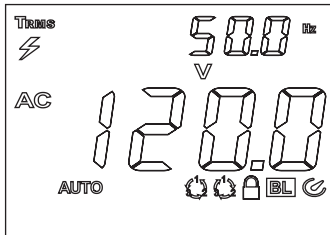

5. PEAK Value Measurement

Press PEAK button in ACV mode to enter peak measurement mode: main display shows ACV value, the secondary display shows P-MAX. Short press PEAK button, "P-MAX" and "P-MIN" will be displayed respectively. Long press PEAK button for at least 2 seconds to exit peak measurement function.

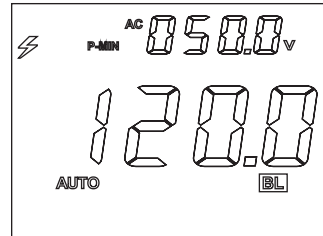
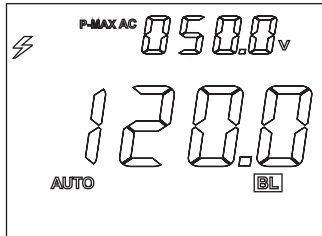

IX. Measurement Operating Instruction

Check the internal 6F22 9V batteries first, if "🔋" or "🔌" symbol appear on the screen, replace the batteries in time. In addition, attention should be paid to the symbol beside the probe sockets, this is to warn you of not exceeding the indicated number for the measured voltage or current so as to guarantee the measurement safety.

1. AC/DC Voltage Measurement (See Figure 1)

- 1) Put in parallel the meter to the load for measurement.
- 2) When meter input impedance is about $10M\Omega$, this kind of load may cause measurement error in high impedance circuit. In most cases, if circuit impedance is less than $10k\Omega$, the error can be ignored (0.1% or less).

3) AC measurement value is true RMS.

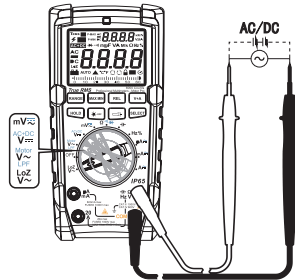
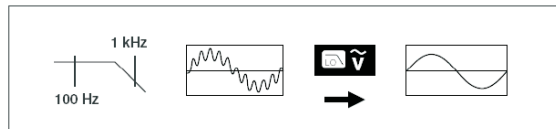

Figure 1

2. Low Pass Filter (LPF) Measurement

- 1) Put in parallel the meter to the load for measurement.
- 2) In ACV mode, press SELECT button to enter LOW PASS FILTER, this filter can intercept voltage higher than 1 kHz. As shown in the following figure, the low pass filter can measure the combined sine wave signal generated by the inverter and variable frequency motor.



3. PEAK Value Measurement

- 1) Put in parallel the meter to the load for measurement.
- 2) Press PEAK button once to activate the peak value detection function. Response time of capture is 250 μ s, it can precisely measure the transient values of P-MAX and P-MIN. Long press PEAK button to exit peak measurement.

4. MOTOR Phase Sequence Measurement Function (See Figure 2)

- 1) Put in parallel the meter to the load for measurement.
- 2) In ACV mode, long press SELECT button for no less than 2 seconds to enable the MOTOR phase rotation measurement function, at this moment, LCD screen will show flashing "🔒" symbol.
- 3) Set the first voltage source for COM terminal, fix the black probe at L3, the red probe will measure L1 for the first time. Wait until the "🔒" on the LCD is locked, change the red probe to L2 within 5 seconds, now the 1-2-3 symbol will be displayed on LCD, indicating forward rotation phase sequence.
- 4) Set the first voltage source for COM terminal, fix the black probe at L3, the red probe will measure L2 for the first time. Wait till the "🔒" on the LCD is locked, change the red probe to L1 within 5 seconds, now the 3-2-1 symbol will be displayed on LCD, indicating reverse rotation phase sequence.
- 5) During the measurement, short press SELECT button once to restart the MOTOR measurement.
Long press SELECT button for at least 2 seconds again to exit the MOTOR phase rotation measurement function.

JT2003

Professional Multimeter User Manual

⚠ Note:

- 1) Phase sequence measurement condition:
Above AC 80V, frequency is 40 Hz to 80 Hz, the flashing "🔒" symbol will be displayed on LCD screen and it will keep on waiting if range of frequency response is exceeded.
- 2) Multi-harmonic anti-interference decoding mode is set in the chip of JT2003. The high-frequency interference signal will be filtrated by a special filter circuit built in the chip, this will be suitable for the measurement in variable-frequency voltage fields. Measurement phase sequence lock time is about 10s more or less.
- 3) When measuring JT2003 products in variable frequency condition, due to the impact of multiple-harmonic PWM, measurement phase sequence lock time is much slower (about 30s more or less), and the frequency range is only suitable from 50 Hz to 80 Hz, and the unstable state of phase sequence measuring may occur.

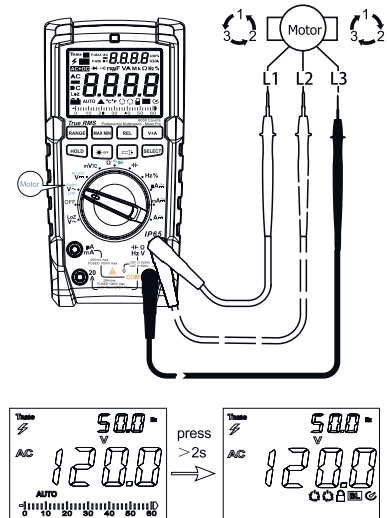

Figure 2

5. LoZ (Low impedance) Measurement.

- 1) Put in parallel the meter to the load for measurement.
- 2) To eliminate the stray voltage, the LoZ {Low impedance is about 300k Ω } function of meter provides a low impedance on the whole conductor circuit so as to obtain much more accurate measurement value. Turn rotation switch to LoZ, meter displays AC voltage in main display.

Note:

- Do not input voltage higher than 1000Vrms. Much higher voltage is possible to be measured, but the meter may be damaged.
- When measuring high voltage, special attention should be paid to avoid electric shock.
- In low pass filter measurement mode, meter will automatically change to manual mode. Press RANGE button to select corresponding range.
- Measure the known voltage before using the meter to confirm whether the function of the product is correct or not.

6. Resistance and Circuit Continuity Measurement (See Figure 3a+3b).

- 1) Put in parallel the meter to the load for measurement.

Note:

- If open circuit or resistance value of measured resistance exceeds the meter maximum range, the "OL" will be displayed.
- When measuring on-line resistance, turn off all power supplies in measured circuit and discharge all residual charges on all capacitors before measurement. In this way, the correct measuring can be assured.

- In low resistance measurement, probe will cause resistance measurement error of about 0.10Ω to 0.20Ω . To obtain precise reading, first short-circuit the probes, then use REL relative measurement mode to ensure measurement accuracy.
- If the resistance value is less than 0.50Ω when probe is in short circuit, check for any loosening or other causes with the probes.
- When measuring high resistance, the reading will be stable after a few seconds. This is normal for high resistance measurement.
- Use resistance measurement function can self-check the built-in fuses, see Figure 3b for more detail.
- Do not input higher than 30V of DC or AC voltage.
- Circuit continuity measurement: If the resistance between two measured ends is more than 50Ω , the circuit will be considered as open, the buzzer will not sound; if the resistance between two measured ends is no more than 10Ω , the circuit is considered to have good continuity, the buzzer will sound continuously.

⚠Note:

- When checking the on-line circuit continuity, turn off all power supplies in measured circuit and discharge all residual charges on all capacitors before measurement.
- Do not input voltage higher than DC or AC 30V to avoid personal injury.

JT2003

Professional Multimeter
User Manual

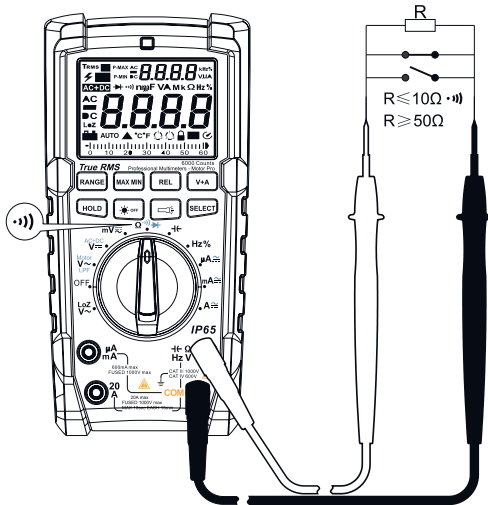

Figure 3a

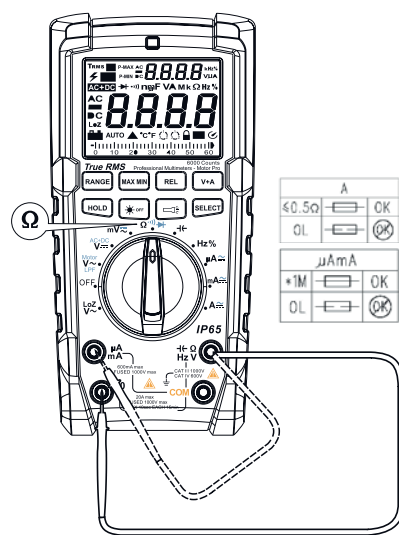

Figure 3b

7. Diode Measurement (see Figure 4).

If measured diode is open circuit or polarity is connected reversely, "OL" will be displayed.
For silicon PN-junction, it is a normal value of about 500 ~ 800mV.

⚠ Note:

- When measuring on-line diode, turn off all power supplies in measured circuit and discharge all residual charges on all capacitors before measurement.
- Diode test voltage range is about 3.0V.
- Do not input voltage higher than DC or AC 30V to avoid personal injury.



Figure 4

8. Capacitance Measurement (See Figure 5).

Meter will display a fixed reading when there is no input, this is the intrinsic capacitance value in the meter. For small range capacitance measurement, measured value must subtract this value to guarantee the measurement accuracy. For this purpose, the relative measurement REL function of the meter can be used to subtract it automatically so as to measure reading conveniently.

⚠ Note:

- If measured capacitance is short circuit or capacitance value exceeds the maximum range of meter, the "OL" will be displayed.
- For large capacitance measurement, it will take several seconds to measure and this is normal.
- Fully discharge the residual charges of the capacitance before measurement, this is much more important for high voltage capacitance this is to avoid meter and personal damage.

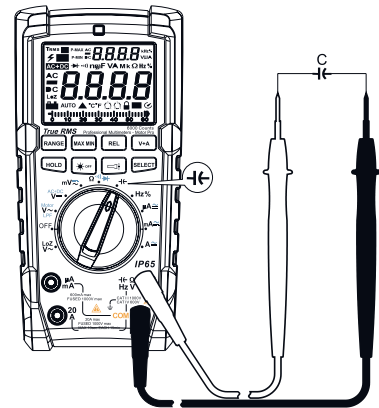

Figure 5

9. Frequency/Duty Ratio Measurement (See Figure 6).

⚠ Note:

- Do not input voltage higher than DC or AC 30V to avoid personal injury.

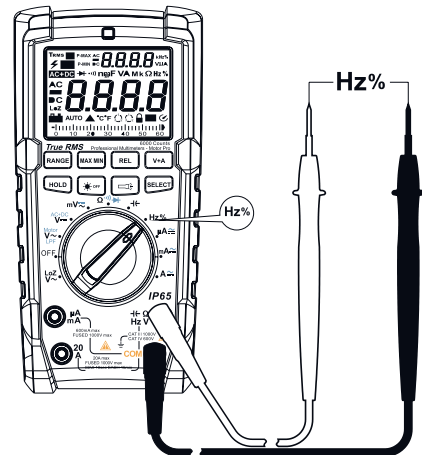

Figure 6

10. AC/DC Current Measurement (See Figure 7).

Connect the meter to the load in series for measurement. AC measurement display value is true RMS.

⚠ Note:

- Before connecting the meter to the loop to be measured, turn off the power supply in the circuit.
- Proper input port and function position should be used during measurement. If current cannot be estimated, start the measurement from a higher range.
- Fuses are set in 20A and mA/ μ A input sockets. Do not put in parallel the probe to any circuit, especially power terminal, for it will damage the meter and endanger personal safety.
- It is available to continuously measure the current up to 10A. When measuring current of 10A-20A, it should not take more than 30 seconds. It is suggested to wait for 15 minutes before measuring low current continuously with the meter after measuring a current higher than 10A.

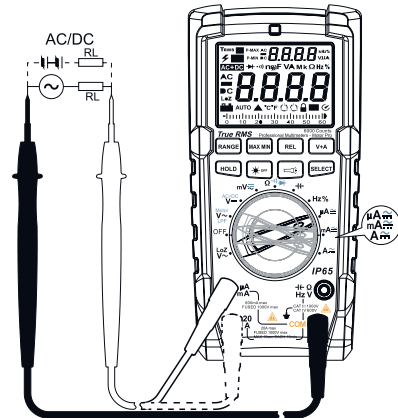



Figure 7

11. Other Functions.

- Auto-off: During measurement, if any knob switch is not turned within about 15 minutes, the meter will turn on the auto-off function to save energy. Rotate function switch in auto-off mode, the meter will automatically wake up.
- Auto backlight: In case the instrument is placed in a dark environment after turning it on, the backlight function will be turned on immediately. If the instrument is placed in a bright environment again, the backlight function will be turned off in 30 seconds. In addition, the auto backlight function will be turned off after pressing OFF button while the backlight is on, if it is necessary to restart the backlight function, just turn off the unit and turn it on again.
- Press and hold SELECT button in power off state and power on the meter, auto-off function will be cancelled.
Recover auto-off function to restart.
- Buzzer: The buzzer will sound when measured AC voltage is more than 750V, DC voltage is more than 1000V and the current value is more than 20A.
- Low voltage testing: Detect the internal VDD while the power is supplied, when it is less than 7.5V,  or  C low battery symbol will be displayed.

X. Technical specifications

Accuracy: $\pm(a\% \text{ reading} + b \text{ number})$, warranty period is 1 year.

Environmental Temperature: $23^{\circ}\text{C} \pm 5^{\circ}\text{C}$ ($73.4^{\circ}\text{F} \pm 9^{\circ}\text{F}$) Relative Temperature: $\leq 75\%$

⚠ Note:

Accurate temperature condition is 18° to 28° , the fluctuation range of ambient temperature is stable in $\pm 1^{\circ}\text{C}$. If the temperature is $< 18^{\circ}\text{C}$ or $> 28^{\circ}\text{C}$, the additional temperature coefficient error is $0.1 \times (\text{specified accuracy})/^{\circ}\text{C}$

1. DC voltage measurement

Range	Resolution power	Accuracy	Description
600.0mV*	0.1mV	$\pm(0.7\%+3)$	
6.000V	0.001V	$\pm(0.5\%+3)$	
60.00V	0.01V	$\pm(0.7\%+3)$	
600.0V	0.1V		
1000V	1V		
6V ~ 60V	- - - -	$\pm(1.5\%+4)$ AC+DC	

⚠ * Input Impedance: mV range is $\geq 1000\text{M}\Omega$, other ranges are $10\text{M}\Omega$ (mV range short circuit allows numbers more than 5, and other ranges will be reset to zero)

⚠ Maximum Input Voltage: $\pm 1000\text{V}$

2. AC Voltage Measurement

Range	Resolution power	Accuracy	Description
600.0mV*	0.1mV	$\pm(1.0\%+4)$	
6.000V	0.001V	$\pm(0.7\%+3)$	
60.00V	0.01V	$\pm(1.0\%+3)$	
600.0V	0.1V	$\pm(1.0\%+3)$	
750V	1V	$\pm(1.0\%+3)$	
Low pass filter measurement 6V ~ 750V		$\pm(2.0\%+3)$	Calculate the deviation based on the measured voltage $\pm(2.0\%+3)$, then divided by and obtain the reading range.
AC LoZ 600.0V	0.1V	$\pm(2.0\%+3)$	Input resistance 300K Ω
PEAK HOLD	V-peak capture time is 250 μ s	$\pm(2.0\%+100)$	Input value $\times \sqrt{2} \pm(2\%+100)$
MOTOR 600.0V	0.1V	$\pm(1.5\%+5)$	

- Input impedance is about 10 M Ω
- Display true RMS.
- Frequency Response: 45 ~ 5 kHz
- Under the condition of variable frequency power supply, the measured voltage value is only for reference.
- When the measured voltage frequency is greater than 1 kHz the accuracy needs to add 5 words

- Allow the meter to stabilize for 1 minute after LoZ (Low impedance 300K) function is used.
- Guaranteed range of accuracy: range of 5~100%, short circuit is allowed to have remain readings less than 10 digits.
- The AC wave peak factor is up to 3.0 in full value (except 1000V range, this range is 1.5 in full value).

Non-sine waveform:

Wave peak factor is 1.0 to 2.0, accuracy should be added 1.0%

Wave peak factor is 2.0 to 2.5, accuracy should be added 2.5%

Wave peak factor is 2.5 to 2.0, accuracy should be added 4.0%



- Maximum input voltage: 750Vrms

3. Resistance measurement

Range	Resolution	Accuracy
600.0Ω*	0.1Ω	±(1.0%+2)
6.000KΩ	1Ω	±(0.8%+2)
60.00KΩ	10Ω	
600.0KΩ	100Ω	
6.000MΩ	1KΩ	±(1.2%+3)
60.00MΩ	10KΩ	±(2.5%+5)

* Range: Measured value = Displayed value - Probe short circuit value
Overload protection: 1000V

4. Circuit Continuity, Diode Measuring

Range	Resolution	Remarks
	0.1Ω	Set resistance value when circuit is disconnected to more than 50Ω, and buzzer does not sound. Set resistance value when circuit is connected well to no more than 10Ω, and buzzer sound continuously.
	1mV	Open-circuit voltage is about 3.0V The normal voltage value of silicon PN-junction is about 0.5 to 0.8V.

 Overload protection: 1000V

5. Capacitance measuring

Range	Resolution	Accuracy
		In REL mode
6.000nF	1pF	±(3%+10)
60.00nF ~ 600.0μF	10pF ~ 0.1μF	±(3%+5)
6.000mF ~ 60.00mF	1μF ~ 10μF	± 5%

 Overload protection: 1000V

It is suggested that measured capacitance no more than 1μF should be measured in REL measurement mode to ensure measurement accuracy.

6. Frequency/Duty Ratio Measurement

Range	Resolution power	Accuracy
100.00Hz ~ 40.00MHz	0.01Hz(0.1H) ~ 0.01mHz	$\pm(0.1\%+4)$
0.1% ~ 99.9%	0.1%	$\pm(2\%+5)$

⚠ Overload protection: 1000V

Input amplitude (a): (DC level is zero)

≤ 100 kHz: $200\text{mVrms} \leq a \leq 30\text{Vrms}$

$> 100\text{kHz} \sim 1\text{MHz}$: $600\text{mVrms} \leq a \leq 30\text{Vrms}$

$> 1\text{MHz} \sim 10\text{MHz}$: $1\text{Vrms} \leq a \leq 30\text{Vrms}$

$> 10\text{MHz}$: $1.8\text{Vrms} \leq a \leq 30\text{Vrms}$

Duty ratio%: Only suitable for measurement less than 10kHz,

Input sensitivity is $>2\text{Vpp}$ @ duty cycle= 10.0% & 95.0%)

Frequency ≤ 1 kHz Duty cycle 10.0%-95.0%

Frequency > 1 kHz Duty cycle 30.0%-70.0%

7. DC Current Measurement

Range		Resolution Power	Accuracy
μA	600.0 μA	0.1 μA	±(0.8%+3)
	6000 μA	1 μA	
mA	60.00 mA	10 μA	
	600.0 mA	0.1 mA	
A	6.000 A	1 mA	±(1.0%+3)
	20.00 A	10 mA	±(1.2%+5)

* Available to continuously measure the current up to 10A. When measuring the current of 10A ~ 20A, it should not take more than 30 seconds, we suggest to wait for 15 minutes before measuring the low current continuously with the instrument after measuring the current of more than 10A.

Overload protection:

μA mA range: F1 fuse (Φ6x32) mm FF 600mA H 1000V (CE)

20A range: F2 fuse (Φ10x38) mm FF 11A H 1000V (CE)

8. AC Current Measurement

Range		Resolution Power	Accuracy
μA	600.0 μA	0.1 μA	±(1.0%+3)
	6000 μA	1 μA	
mA	60.00 mA	10 μA	
	600.0 mA	0.1 mA	
A	6.000 A	1 mA	±(1.2%+3)
	20.00 A	10 mA	±(1.5%+5)

* Available to continuously measure the current up to 10A. When measuring the current of 10A~20A, it should not take more than 30 seconds, we suggest to wait for 15 minutes before measuring the low current continuously with the instrument after measuring the current of more than 10A. Frequency response: 45~5 kHz

Display true RMS

Accuracy Guaranteed Range: range of 5-100%, short circuit is allowed to have remain readings less than 2 digits. The AC wave peak factor is up to 3.0 in full value.

Non-sine waveform: Wave peak factor is 1.0 to 2.0, accuracy should be added 1.0%

Wave peak factor is 2.0 to 2.5, accuracy should be added 2.5%

Wave peak factor is 2.5 to 2.0, accuracy should be added 4.0%

⚠ Overload protection: (Overload protection for similar DC current measurement)

XI. Maintenance and Repair

⚠ Warning: Before opening the back cover of the instrument, ensure that the power supply has been turned off and probes have been removed from the input ports and the measured circuit.

1. General Maintenance and Repair

- * Please use wet cloth and a gentle cleaning agent to clean the case, do not use a grinding agent or solvent.
- * If any abnormality is found with the meter, stop using it and send it for repairing.
- * If need to check or repair the meter, please ask for qualified special maintenance personnel or authorized maintenance department.

2. Batteries and Fuse Replacement

If LCD display shows undervoltage or symbol, replace the built-in batteries immediately, otherwise the measurement accuracy will be influenced. Battery specification is 6F22 9V.

Operation Steps:

1. Set the power switch to "OFF", remove the probes from the input sockets, and take away the protective case.
2. Use a screwdriver to unscrew 3 fixed screws in the battery back cover, remove the battery back cover and replace.

Undervoltage old batteries and blown fuse:

F1 fuse (Φ6x32) mm FF 600mA H 1000V (CE)

F2 fuse (Φ10x38) mm FF 11A H 1000V (CE)

JT2003

Professional Multimeter
User Manual

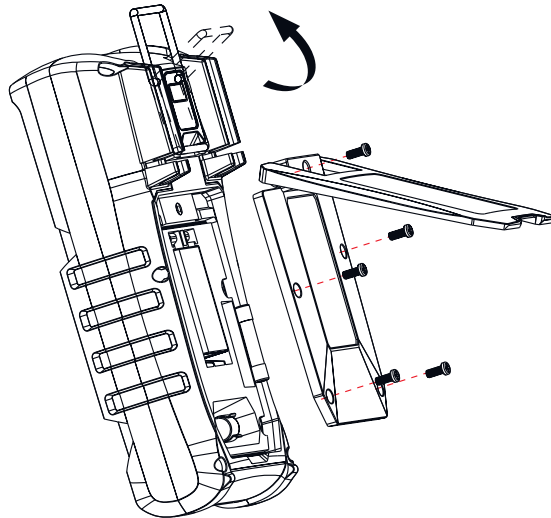

Figure 9

JT2003

Professional Multimeter
User Manual



COJALI S.L.

Avenida de la Industria N3 · 13610 · Campo de Criptana · Spain

National Tel: +34 926 589 670

International Tel: +34 926 589 671

www.cojali.com · www.jaltest.com